

AFGROW Users Workshop 2024

AFGROW Current Release and Release 5.5 Overview

Alex Litvinov, James Harter, Matthew Gross
LexTech, Inc .

Agenda

1. Current AFGROW release 5.4 overview
2. AFGROW Release 5.5 completed items list
3. List of AFGROW Release 5.5 features that are still in development
4. New Spectrum Manager features
5. Post-Processing Application

- New/Enhanced Advanced Crack At Hole Solutions (combination of a corner crack and through crack at a hole)
- Multi-site Damage solutions
- New width correction for an advanced corner crack(s) at a hole
- New single and double through crack at a hole weight function solutions
- Local material database in tabular-lookup format
- 35 new crack initiation material data sets
- Option to open Tabular Lookup material data file through COM
- Modified output preferences: Add a check box to put output file in the same folder as input file. Allow the for each output file type to have the same name as an input file
- Option to use plugin from COM
- Better handling life in hours output. Output intervals printed in "hours" if the option to display life in hours is selected in the Output Intervals tab, the crack length plots are also converted to hours
- Print NASGRO material id in AFGROW output, save NASGRO model id in the AFGROW problem definition file
- Added Correction for a filled, unloaded hole for advanced models
- Added access to retardation metadata via Plug-in Interface
- Added prediction result information to AFGROW output XML file
- Implemented API 579 *Stress Intensity Factor Solutions for Cylinders* (22 new K models)
- Added CorLAS™ Burst Pressure Model
- Added ability to Spectrum Manager to generate spectrum from Max/Min Data (exceedance curve)
- Spectrum Manager is included in AFGROW installation

Combination of a Corner Crack and Through Crack at a Hole Solution

- Based on Börje Anderson SSHF2017 Database: *Straight Shank Hole with crack originating at Faying Surface*
- SSHF2017 Database contains only Corner Crack – Oblique Crack at Hole combination. The Corner Crack – Through Crack solution was generate by finding a limit value of K for the Oblique Crack, when its virtual A length goes to infinity
- Corner Crack – Through Crack solution can be used by itself or as a transition model from the Double Corner Cracks at Hole solution
- In the current AFGROW implementation, the solution parameters cover the following range:
 - $0.333 \leq R/T \leq 2$
 - $0.0 \leq A1/T \leq 0.95$
 - $0.1 \leq A1/C1 \leq 10$
 - $0.01 \leq C1/C2 \leq 6.0$
- R/T range will be extended to be between 0.1 and 10 in subsequent releases



Multisite Damage Solutions (MSD)

Multiple Through Cracks in an Infinite Plate

- Axial load case
- 3 to 9 cracks Multiple Holes in an Infinite Plate (Continuing Damage)

Axial and bearing load cases

- Primary and Secondary Crack at the Center Hole
- Single Secondary Crack on Outside of each adjacent hole (2, 4, 6, or 8 holes)

Multiple Holes in an Infinite Plate (Multisite Damage)

- Axial and bearing load cases
- Primary and Secondary Crack at the Center Hole
- Single Secondary Crack on Outside of each adjacent hole (2, 4, 6, or 8 holes)

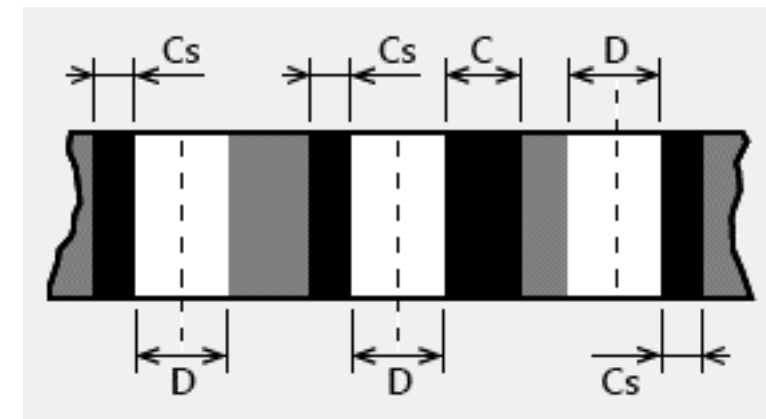
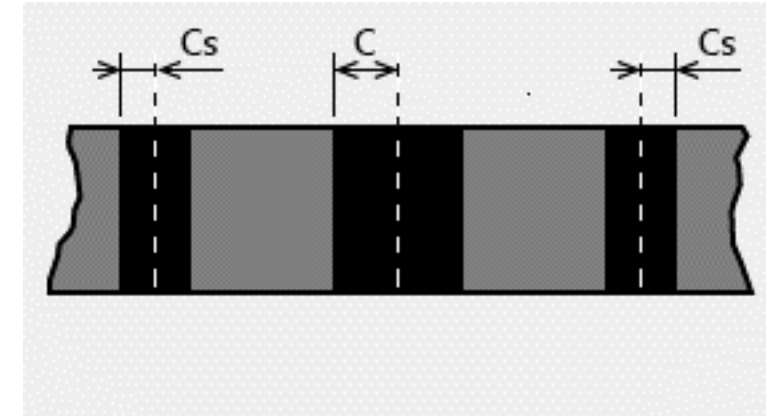

Width Correction for a Advanced Corner Crack(s) at a Hole Solution

- The through crack finite width correction is used as the baseline solution for all 3-D finite width corrections
- The 3-D width correction must converge to the 2-D correction as $(a/t, a, \& c) \rightarrow 0$ (both directions) and $a/t \rightarrow 1$ (c-direction only)
- The baseline solution for $a=c=0$ is the unflawed Kt value for any W/D divided by 3
- AFGROW used the 1986 Newman/Raju width correction (F_w) with $a/t = 1$ and a modification (F_{ww}) to correct it for $W/D \leq 6$
- This has recently been reviewed, and a new correction has been developed and is available as an option in Predict, Preferences
- We would like the correction to apply for $W/D \geq 1.5$
- Thanks to Adrian Loghin and Scott Prost-Domasky for all of their help with FE validation solutions

Single and Double Through Crack at Hole Weight function Solutions

Based on Jihwi Kim, Michael R. Hill (*Department of Mechanical and Aerospace Engineering, University of California*) paper: “*Weight functions for a finite width plate with single or double radial cracks at a circular hole*” that was published in *Engineering Fracture Mechanics* and also presented at AFGROW Workshop 2016

Single Edge Corner Crack Weight Function Solution

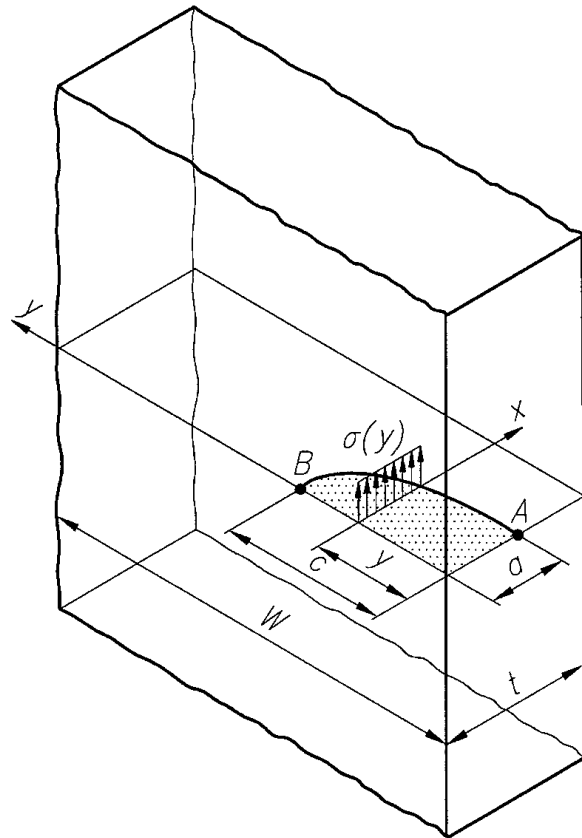

Based on Glinka, G., PhD, DSc., “*Quarter-elliptical corner crack in a finite thickness plate – in plane stress distribution*” delivered to LexTech, Inc. as part of the contract with SAFFD, Inc., Mannheim, Ontario, Canada

Can be used to model the single edge corner crack

Local Material Database in the Tabular-Lookup format

- Based on AFMAT Raw Data
- Searchable by material name and material type
- Data can not be modified
- AFGROW can be configured to be used the database on local computer, network server or company intranet
- There are currently tabular curve fits for 85 materials in the database are available

Download Data File

Material	Alloy	Description
All Materials		
ALLOY STEELS		
10NI STEEL L-T STW PLATE	ALLOY STEELS	10NI STEEL L-T STW PLATE
18Ni Maraging L-T	ALLOY STEELS	18Ni Maraging L-T
300M L-T Lab Air Forging	ALLOY STEELS	300M L-T Lab Air Forging
4130 L-T Lab air	ALLOY STEELS	4130 L-T Lab air
4340 180 Ksi L-T HHA	ALLOY STEELS	4340 180 Ksi L-T HHA
4340 L-T 160-180 UTS Plt+Frg Lab air Temp ...	ALLOY STEELS	4340 L-T 160-180 UTS Plt+Frg L...
AERMET 100 L-T HHA Forging and Bar	ALLOY STEELS	AERMET 100 L-T HHA Forging a...
AERMET 100 T-L HHA Forging and Bar	ALLOY STEELS	AERMET 100 T-L HHA Forging a...
API X60-X75 Pipeline Steel	ALLOY STEELS	API X60-X75 Pipeline Steel
H-11 AUST;T L-T ROUND BAR	ALLOY STEELS	H-11 AUST;T L-T ROUND BAR
ALUMINUM 2000/6000 ALLOYS		
2014-T6 L-T Lab air Sheet	ALUMINUM 2000/6000 ALLOYS	2014-T6 L-T Lab air Sheet
2020-T651 L-T Lab air Plate	ALUMINUM 2000/6000 ALLOYS	2020-T651 L-T Lab air Plate
2024-T3 Lab Air L-T	ALUMINUM 2000/6000 ALLOYS	2024-T3 Lab Air L-T
2024-T3 T-L Lab Air Sheet	ALUMINUM 2000/6000 ALLOYS	2024-T3 T-L Lab Air Sheet
2024-T351	ALUMINUM 2000/6000 ALLOYS	2024-T351
2024-T3511 Lab Air L-T	ALUMINUM 2000/6000 ALLOYS	2024-T3511 Lab Air L-T
2024-T851 lab air L-T	ALUMINUM 2000/6000 ALLOYS	2024-T851 lab air L-T
2090-T86 T-L Lab air TEE Extrusion	ALUMINUM 2000/6000 ALLOYS	2090-T86 T-L Lab air TEE Extrusi...
2091-T8 T-L HHA PLT&SHT	ALUMINUM 2000/6000 ALLOYS	2091-T8 T-L HHA PLT&SHT
2124-T851 lab air L-T	ALUMINUM 2000/6000 ALLOYS	2124-T851 lab air L-T
2219-T851 L-T Dry air Plate	ALUMINUM 2000/6000 ALLOYS	2219-T851 L-T Dry air Plate
2219-T87 lab air T-L	ALUMINUM 2000/6000 ALLOYS	2219-T87 lab air T-L
2224-T3511 L-T Lab Air Extrusion	ALUMINUM 2000/6000 ALLOYS	2224-T3511 L-T Lab Air Extrusion
2324-T39 lab air & HHA L-T	ALUMINUM 2000/6000 ALLOYS	2324-T39 lab air & HHA L-T
		TestDescript

Tabular Lookup Database, 82 entries

OK Cancel

New Crack Initiation Material Parameter Data

Material Browser

Material	Hardness(a)	Product Condition(b)	UTS, MPa	TYS, MPa	σ _s , MPa	RA, %	EL, %	E, GPa	n'	K', MPa	SIGF, MPa	b	EPSF'	c
All Materials														
ALLOY STEELS														
SAE 950-120	120 HB	As-received	440	375	960	66		204	0.158	875	811.6	-0.095	1.027	-0.63
SAE 950-150	150 HB	As-received	539	385	1000	64		204	0.16	1000	825	-0.08	0.425	-0.55
SAE 950-180	180 HB	As-received	575	450	1150	70		204	0.175	1500	1000	-0.08	0.25	-0.45
SAE 980-160	160 HB	As-received	637	560	1200	64		206	0.15	1300	1200	-0.105	2.5	-0.8
SAE 980-200	200 HB	As-received	675	585	1325	68		206	0.155	1350	1150	-0.09	1.25	-0.7
SAE 980-225	225 HB	As-received	699	595	1250	67		206	0.16	1400	1170	-0.085	1.25	-0.72
SAE-AISA 1035 Steel		Hot-rolled	476	250	751	56		196	0.24	1185	906	-0.11	0.33	-0.47
SAE-AISA 1035 Steel		Quenched & Tempered	1900	1450	2172	40		200	0.15	2500	3690	-0.13	0.2	-0.63
SAE-AISI 1005 Steel		Hot-rolled	338	230	907	77		207	0.255	1152	882	-0.135	0.37	-0.52
SAE-AISI 1006 Steel	85HB	Hot-rolled	318	248		73		207	0.243	1064	775	-0.125	0.607	-0.53
SAE-AISI 1015 Steel	80HB	Normalized	415	227	725	68		206	0.24	1058	976	-0.14	0.76	-0.59
SAE-AISI 1025 Steel		Hot-rolled	555	345	1035	60		205	0.195	1130	957	-0.095	0.45	-0.5
SAE-AISI 1030 Steel	128HB	Hot-rolled	454	289	764	59		206	0.28	1410	735	-0.105	0.1	-0.35
SAE-AISI 1045 Steel		Hot-rolled	671	327	1061	44		216	0.22	1402	1099	-0.11	0.52	-0.54
SAE-AISI 1045 Steel	500HB	Quenched & Tempered	1825	1688	2273	51		206	0.12	2650	2165	-0.08	0.22	-0.66
SAE-AISI 1045 Steel	225HB	Annealed	751	516	998	44		203	0.17	1178	960	-0.08	0.5	-0.52
SAE-AISI 1080 Steel	371/410HB	Quenched & Tempered	1365	1189	1698	32		204	0.145	2052	1860	-0.09	0.65	-0.62
SAE-AISI 1080 Steel	421HB	Austempered	1349	978	1645	32		204	0.21	3177	2364	-0.1	0.51	-0.59
SAE-AISI 4130 Steel	362/371HB	Quenched & Tempered	1426	1357	1819	54		199	0.13	1837	1731	-0.08	0.84	-0.68
SAE-AISI 4130 Steel	253/265HB	Quenched & Tempered	895	778	1419	67		220	0.13	1359	1273	-0.08	1.51	-0.72
SAE-AISI 4340 Steel	237/247HB	Hot-rolled	826	634	1088	43		192	0.17	1384	1232	-0.1	0.53	-0.56
SAE-AISI 4340 Steel	350HB	Quenched & Tempered	1205	1140	1750	57		199	0.14	1862.96	1944.32	-0.1	1.22	-0.73
SAE-AISI 4340 Steel	400HB	Quenched & Tempered	1467	1371	1557	38		199	0.13	1950	1898	-0.09	0.67	-0.64
ALUMINUM 1100 ALLOYS														
1100 Al	28HB	As-received	110	97		87.6		69.05	0.159	184	159	-0.092	0.467	-0.613
ALUMINUM 2000/6000 ALLOYS														
2014-T6	135HB	As-received	511	463	628	25		69.05	0.072	704	776	-0.091	0.269	-0.742
2024-T3	120HB		486	360			17.3	72	0.04	590	1044	-0.114	1.765	-0.927
2024-T351	120HB		469	324	138			73.1	0.09	786.002	1013.53	-0.11	0.21	-0.52
2024-T4	120HB	STA	476	304	140	35		70.43	0.098	808	764	-0.075	0.334	-0.649
Alloy 6082	93HB	STA	330	290	95			70	0.051	397	611	-0.099	1.085	-0.857
ALUMINUM 5000 ALLOYS														
5456-H311	56HB	As-received	350	235	566	34.6		69.05	0.084	636	702	-0.102	0.2	-0.655
ALUMINUM 7000/8000 ALLOYS														
7075-T6	150HB		560	480	159			70	0.1	965.266	1316.9	-0.126	0.19	-0.52
7075-T61	150HB		565	470		33		70.5	0.081	883	1050	-0.099	0.355	-0.782
7075-T65	150HB		570	500				72	0.075	910	1294	-0.1	0.5	-0.915
7075-T73	140HB		500	410	160			70	0.032	510.212	799.792	-0.098	0.26	-0.73
7075-T7651	150HB		462	382			8.4	71	0.094	695	989	-0.14	6.812	-1.198
NICKEL BASED SUPER ALLOYS														

OK Cancel

Open Tabular Lookup Material Data File Using COM

```
Option Explicit
Private Sub CommandButton1_Click()
    Dim af As Afgrow.Application
    Set af = CreateObject("Afgrow.Application")

    af.Visible = True

    Dim mat As Afgrow.TabularLookupMaterial
    Set mat = af.SetTabularLookupMaterial

    Dim b As Boolean
    b = mat.OpenFile(Cells(2, 3))

    Dim young As Double
    young = mat.dYoungModulus
    mat.dUltimateStrength = 68

    af.ConstAmplitudeSpectrum 0#
    af.SMF = 14

    Dim Cycles As Double
    Dim finalC As Double
    Dim finalA As Double
    Dim finalCt As Double
    Dim finalKc As Double
    Dim finalKa As Double
    Dim finalKct As Double
    af.RunFrozPredict Cycles, finalC, finalKc, finalA, finalKa, finalCt, finalKct

    af.Quit
End Sub
```

Enhanced Output Preferences

- Add a check box to put output file in the same folder as input file.
- Allow the for each output file type to have the same name as an input file.

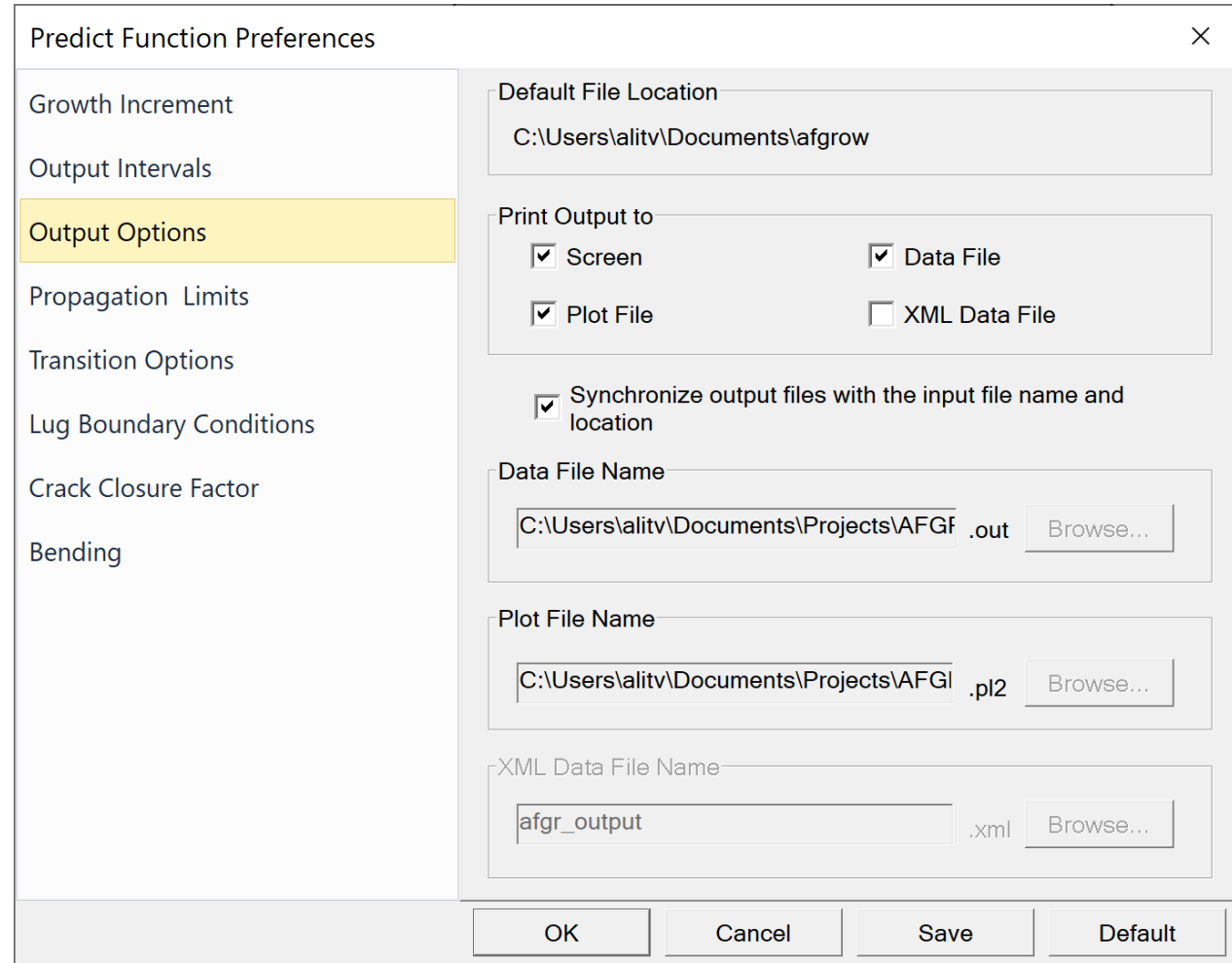

Predict Function Preferences

Growth Increment

Output Intervals

Output Options

Propagation Limits

Transition Options

Lug Boundary Conditions

Crack Closure Factor

Bending

Default File Location
C:\Users\alitiv\Documents\afgrow

Print Output to

Screen Data File

Plot File XML Data File

Synchronize output files with the input file name and location

Data File Name
C:\Users\alitiv\Documents\Projects\AFGI .out Browse...

Plot File Name
C:\Users\alitiv\Documents\Projects\AFGI .pl2 Browse...

XML Data File Name
afgr_output .xml Browse...

OK Cancel Save Default

```
1 public static void RunPluginModelAdditions()
2 {
3     Afgrow.Application af = new Afgrow.Application();
4     af.Visible = true;
5     af.PluginModel.LoadPlugin("VZLUPugin.VZLUPuginClass");
6     bool b = af.PluginModel.SetProperty("Crack Length", 0.25);\
7     b = af.PluginModel.SetProperty("Bottom Length", 0.5);
8     b = af.PluginModel.SetProperty("Top Length", 0.8);
9     b = af.PluginModel.SetProperty("Top Radius", 0.9);
10    b = af.PluginModel.SetProperty("Thickness", 0.3);
11
12    double d = af.PluginModel.GetProperty("Crack Length");
13    d = af.PluginModel.GetProperty("Bottom Length");
14    d = af.PluginModel.GetProperty("Top Length");
15    d = af.PluginModel.GetProperty("Top Radius");
16    d = af.PluginModel.GetProperty("Thickness");
17
18    af.ConstAmplitudeSpectrum(0.0);
19    af.SMF = 14;
20
21    double cycles;
22    double Kc;
23    double Ka;
24    af.RunFrozPredict(out cycles, out _, out Kc, out _, out Ka, out _, out _);
25
26    Console.WriteLine(cycles + "\n");
27    Console.ReadLine();
28    af.Quit();
29 }
```

Consist of 3 functions:

```
void LoadPlugin(BSTR fileName);
```

```
boolean SetProperty(BSTR propertyID, VARIANT value);
```

```
VARIANT GetProperty(BSTR propertyID);
```

Life in Hours Output – What Do We Do with a Time Dependent Spectrum?

Print hours and cycles



C Crack size= 1.089 Beta Tension= 1.2170 Beta Compression= 1.2170 R(k)= 0.0000 R(final)= 0.0000 Max stress = 14.000 r = 0.00 57100 Cycles Subspectra: 0 Pass: 572 Hours: 1142	Delta k=3.1513e+01 D()/DN=3.0626e-04
C Crack size= 1.1196 Beta Tension= 1.2498 Beta Compression= 1.2498 R(k)= 0.0000 R(final)= 0.0000 Max stress = 14.000 r = 0.00 57200 Cycles Subspectra: 0 Pass: 573 Hours: 1144	Delta k=3.2816e+01 D()/DN=4.4571e-04
C Crack size= 1.1642 Beta Tension= 1.2498 Beta Compression= 1.2498 R(k)= 0.0000 R(final)= 0.0000 Max stress = 14.000 r = 0.00 57300 Cycles Subspectra: 0 Pass: 574 Hours: 1146	Delta k=3.3463e+01 D()/DN=5.5443e-04
C Crack size= 1.2196 Beta Tension= 1.3171 Beta Compression= 1.3171 R(k)= 0.0000 R(final)= 0.0000 Max stress = 14.000 r = 0.00 57400 Cycles Subspectra: 0 Pass: 575 Hours: 1148	Delta k=3.6095e+01 D()/DN=2.1559e-03

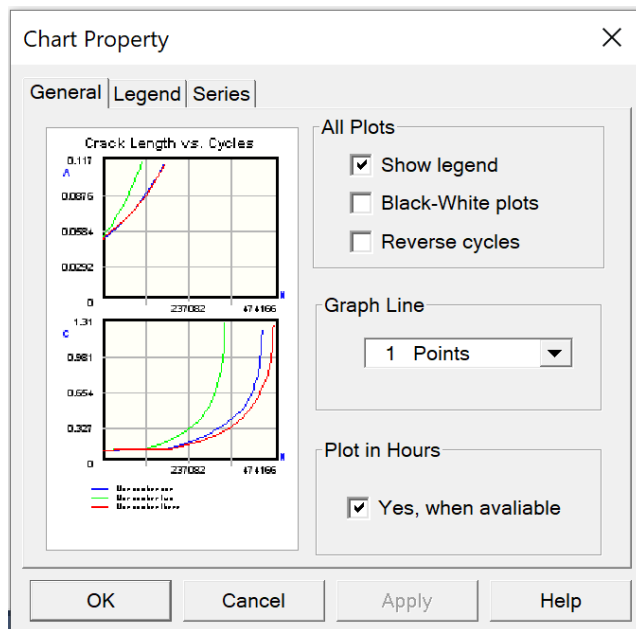

- Let user decide what to see in the plot view.
- “Crack Length vs. Cycles” graph will be in hours only if “Yes” button is checked in and plots are covetable to hours

New Life in Hours Output Options

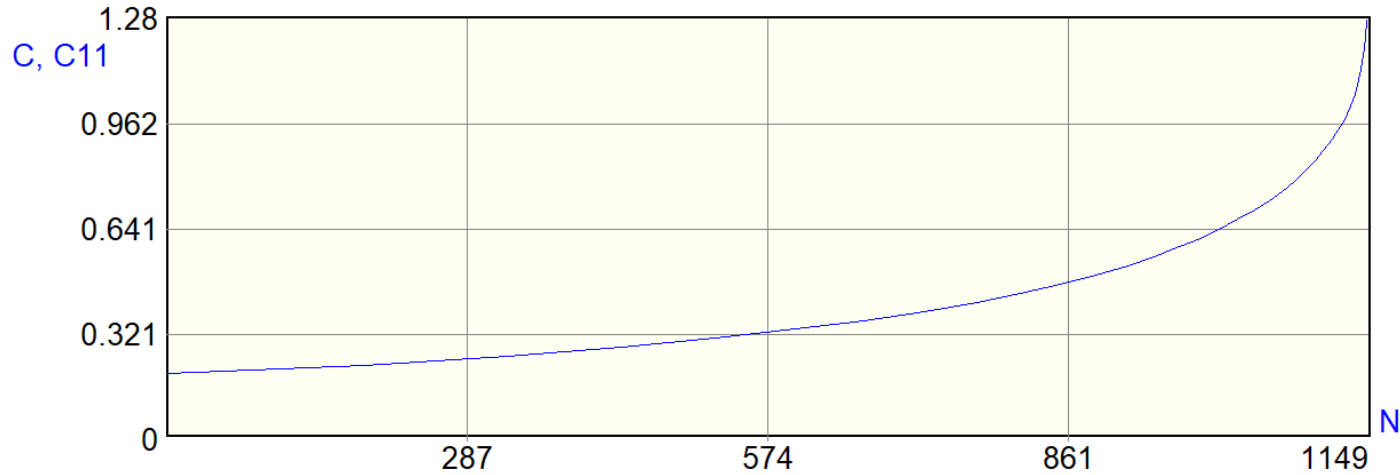

← The crack length plots converted to hours if the option to display life in hours is selected

Internal Through Crack - Standard Solution

Output intervals printed in "hours" if the option to display life in hours is selected



Output			
Max stress =	14.000	r = 0.00	57000 Cycles Subspectra: 0 Pass: 571 Hours: 1140
C Crack size=	1.089	Beta Tension= 1.2170	Beta Compression= 1.2170 R(k)= 0.0000 R(final)= 0.0000
Max stress =	14.000	r = 0.00	57100 Cycles Subspectra: 0 Pass: 572 Hours: 1142
C Crack size=	1.1196	Beta Tension= 1.2498	Beta Compression= 1.2498 R(k)= 0.0000 R(final)= 0.0000
Max stress =	14.000	r = 0.00	57200 Cycles Subspectra: 0 Pass: 573 Hours: 1144
C Crack size=	1.1642	Beta Tension= 1.2498	Beta Compression= 1.2498 R(k)= 0.0000 R(final)= 0.0000
Max stress =	14.000	r = 0.00	57300 Cycles Subspectra: 0 Pass: 574 Hours: 1146
C Crack size=	1.2196	Beta Tension= 1.3171	Beta Compression= 1.3171 R(k)= 0.0000 R(final)= 0.0000
Max stress =	14.000	r = 0.00	57400 Cycles Subspectra: 0 Pass: 575 Hours: 1148
*****Fracture based on 'Kmax' Criteria (current maximum stress)			
C Crack size=	1.2821	Beta Tension= 1.3677	Beta Compression= 1.3677 R(k)= 0.0000 R(final)= 0.0000
Max stress =	14.000	r = 0.00	57429 Cycles Subspectra: 0 Pass: 575 Hours: 1148.58
Stress State in the 'C' direction (PSC): 2			
Fracture has occurred- run time: 0 hour(s) 0 minute(s) 1 second(s)			
1148.5800 hours have passed			

NASGRO Material Model Changes

- Improved data selection
- Material code is displayed in the output
- Material code is saved in the AFGROW problem definition file

Material Database Browser

OK Cancel

Search Search Search Search E1

C:\Users\alvtv\Docume...

- ASTM spec. grade s... ASTM spec. grade s...
- A200 series ASTM spec. grade s... A200 series
- AISI-SAE designatio... AISI-SAE designation...
- Trade/common nam... Trade/common name...
- Ultra high strength Trade/common name... Ultra high str...
- 18Ni maragin... Trade/common name... Ultra high str... 18Ni maragin...
- 250 Grd; ... Trade/common name... Ultra high str... 18 Ni Maraging 250 Grd; Plt & Forg E1AD10AB1
- 18Ni maragin... Trade/common name... Ultra high str... 18Ni maragin...
- 300M Trade/common name... Ultra high str... 300M
- AF1410 Trade/common name... Ultra high str... AF1410
- D6AC Nom. ... Trade/common name... Ultra high str... D6AC Nom....
- D6AC High ... Trade/common name... Ultra high str... D6AC High ...
- HP-9-4-20 Plt... Trade/common name... Ultra high str... HP-9-4-20 Plt...
- HP-9-4-20 G... Trade/common name... Ultra high str... HP-9-4-20 G...
- HP-9-4-30 Trade/common name... Ultra high str... HP-9-4-30
- HY-180(10Ni) Trade/common name... Ultra high str... HY-180(10Ni)
- HY-TUF Trade/common name... Ultra high str... HY-TUF
- H-11 MOD Trade/common name... Ultra high str... H-11 MOD
- AISI type stainless st... AISI type stainless steel
- Misc. CRES/heat re... Misc. CRES/heat resi...
- Ni alloys/superalloys Ni alloys/superalloys

Alloy	Heat Treatment/Product Form	Type	Category
A536 Grd 80-55-06	as cast	ASTM specification	Iron, alloy o
A36 Plt	Plt(Dyn Klc, <500Hz); LA, HHA, 3% NaCl	A10 series	ASTM spec
A203 Grd E (3.5% Ni)	Plt	A200 series	ASTM spec
A203 Grd E (3.5% Ni)	Plt; -100F	A200 series	ASTM spec
A469 Cl4 Forg	Cl4 Forg	A400 series	ASTM spec
A469 Cl5 Forg	Cl5 Forg	A400 series	ASTM spec
Low Carbon 1005-1012	Hot rolled plt	10xx-12xx steels	AISI-SAE d
4330V MOD 180-200 UTS	180-200 UTS; Plt & Forg	43xx-48xx steels	AISI-SAE d
4340 200-220 UTS	200-220 UTS; Plt & Forg	43xx-48xx steels	AISI-SAE d
4340 200-220 UTS	200-220 UTS; Plt & Forg; -50F	43xx-48xx steels	AISI-SAE d
18Ni maraging 250 Grd	250 Grd; Plt & Forg	Ultra high strength	Trade/comi
18Ni maraging 300 Grd	300 Grd; Plt & Forg	Ultra high strength	Trade/comi
300M	Plt & Forg	Ultra high strength	Trade/comi
AF1410	Plt & Forg; LA, HHA/DW > 1Hz	Ultra high strength	Trade/comi
AF1410	Plt & Forg; -65F	Ultra high strength	Trade/comi
D6AC Nom. Klc(70)	Plt & Forg; nom. Klc (70)	Ultra high strength	Trade/comi
D6AC Nom. Klc(70)	Plt & Forg; nom. Klc (70); HHA/DW > 0.1 Hz	Ultra high strength	Trade/comi
D6AC Nom. Klc(70)	Plt & Forg; nom. Klc (70); -40F	Ultra high strength	Trade/comi
D6AC High Klc(90)	Plt & Forg; high Klc (90)	Ultra high strength	Trade/comi
HP-9-4-20 Plt & Forg	Plt & Forg; L-T, T-L; LA, HHA, SW > 1Hz	Ultra high strength	Trade/comi
HP-9-4-20 Plt & Forg	Plt & Forg; L-T, T-L; -65F	Ultra high strength	Trade/comi
HP-9-4-20 GTA Weld	GTA Weld+SR; LA, HHA, SW > 1Hz	Ultra high strength	Trade/comi
HP-9-4-20 GTA Weld	GTA Weld+SR; -65F	Ultra high strength	Trade/comi
HP-9-4-30	Plt & Forg; L-T, T-L; LA, HHA, SW > 1Hz	Ultra high strength	Trade/comi
HP-9-4-30	Plt & Forg; L-T, T-L; -65F	Ultra high strength	Trade/comi
HP-9-4-30	Plt & Forg; L-T, T-L; 600F	Ultra high strength	Trade/comi
HY-180(10Ni)	Plt & Forg	Ultra high strength	Trade/comi
HY-180(10Ni)	Plt & Forg; DW, ASW > 0.1 Hz	Ultra high strength	Trade/comi
HY-180(10Ni)	Plt & Forg; SW > 0.1 Hz	Ultra high strength	Trade/comi
HY-TUF	VAR Forg	Ultra high strength	Trade/comi
H-11 MOD	Plt & Forg	Ultra high strength	Trade/comi
HY 80	Plt	Pressure vessel/piping	Trade/comi
HY 80	Plt; 3.5% NaCl/SW > 0.1 Hz	Pressure vessel/piping	Trade/comi
HY 130	Plt	Pressure vessel/piping	Trade/comi
HY 130	Plt; 3.5% NaCl/SW > 0.1 Hz	Pressure vessel/piping	Trade/comi
HY 130	GMA Weld	Pressure vessel/piping	Trade/comi
HY 130	SMA Weld	Pressure vessel/piping	Trade/comi

NASGRO material database file, 120 entries



Prediction Result Information in AFGROW Output XML file

```
</Event>  
<Result code="0" cycles="57429" spectrum_units="1" spectrum_unit_name="Constant amp." spectrum_pass="575">  
  <Crack id="0">  
    <Dir id="C" length="1.28211" beta_tension="1.36772" beta_compression="1.36772" delta_k="38.4293" dl_dn="0.01" r_k="0" r_final="0"/>  
  </Crack>  
</Result>  
</CrackGrowthOutput>
```

Prediction result code

Number of cycles before prediction stopped

Final length and additional information for every crack direction

Additional spectrum related information

API 579 *Stress Intensity Factor Solutions*

ID	Name	Load	Stress Distribution	Classic Model Equivalent
5010	Longitudinal Through Crack In Cylinder (9B.5.1)	Pressure		2098
5030	Circumferential Through Crack In Cylinder (9B.5.3)	Pressure		2090
5040	Infinite Longitudinal Surface Crack In Cylinder (Internal) (9B.5.4)	Stress	Polynomial	
5041	Infinite Longitudinal Surface Crack In Cylinder (External) (9B.5.4)	Stress	Polynomial	
5060	Infinite Longitudinal Surface Crack In Cylinder (Internal) (9B.5.6)	Stress	WF	
5061	Infinite Longitudinal Surface Crack In Cylinder (External) (9B.5.6)	Stress	WF	
5070	Circumferential Crack In Cylinder (Internal) (9B.5.7)	Pressure		2096
5071	Circumferential Crack In Cylinder (External) (9B.5.7)	Pressure		2095
5090	Circumferential Crack In Cylinder (Internal) (9B.5.9)	Stress	WF	
5091	Circumferential Crack In Cylinder (External) (9B.5.9)	Stress	WF	
5100	Longitudinal Surface Crack In Cylinder (Internal) (9B.5.10)	Pressure		1091
5101	Longitudinal Surface Crack In Cylinder (External) (9B.5.10)	Pressure		1092
5110	Longitudinal Surface Crack In Cylinder (Internal) (9B.5.11)	Stress	Polynomial	
5111	Longitudinal Surface Crack In Cylinder (External) (9B.5.11)	Stress	Polynomial	
5120	Longitudinal Surface Crack In Cylinder (Internal) (9B.5.12)	Stress	WF	3030
5121	Longitudinal Surface Crack In Cylinder (External) (9B.5.12)	Stress	WF	3040
5130	Circumferential Surface Crack In Cylinder (Internal) (9B.5.13)	Pressure		
5131	Circumferential Surface Crack In Cylinder (External) (9B.5.13)	Pressure		1090
5140	Circumferential Surface Crack In Cylinder (Internal) (9B.5.14)	Stress	Polynomial	
5141	Circumferential Surface Crack In Cylinder (External) (9B.5.14)	Stress	Polynomial	
5180	Longitudinal Full-Elliptic Embedded Crack in Cylinder (9B.5.18)	Stress	Polynomial	
5190	Full-Elliptic Embedded Crack in Cylinder (9B.5.19)		Polynomial	

- Enhancement: Add the ability to switch between docking windows using keyboard's CTRL Tab key combination
- Enhancement: Add the ability to switch between an object drop down list and object properties using the keyboard Shift-Tab key combination
- Enhancement: Add the ability to copy from the Output window using CTRL C
- Enhancement: Add the ability to move right to the adjacent column using the Tab key while editing values in the grid control
- Bug: AFGROW crashed for advanced models with one crack and output was directed to a plot file
- Bug: Corrected the Tab order in the Tabular Lookup dialog
- Bug: Hole Offset for Advanced Models was Set Incorrectly through COM using the *SetObjectProperty* function

- Enhancement: Added spectrum statistical information to XML output files
- Enhancement: Improved the Special Case K-solution for through cracks in a row of holes to better account for the effect of fastener loads at adjacent holes.
- Bug: Fixed multiple errors in plot file for Advanced Models. Formatting issues remain that occur after crack(s) transition or coalesce. We will continue to improve plot file formatting issues in future AFGROW releases.
- Bug: Life prediction error when API-579 models used via COM without setting any model parameters.
- Bug: Advanced internal through crack did not recalculate the crack offset when a new crack length was set.
- Bug: When adding an internal through crack using the COM interface for Advanced Models, AFGROW used the total crack length instead the half-length, and calculated the offset from the left edge of the crack, instead of the crack center.
- Bug: The constant AoC setting was lost for advanced double corner cracks at hole when the first crack transitions to a slot
- Bug: Advanced model for 2 internal through cracks sometimes crashed during transition (coalescence)
- Bug: XML output for the offset through crack model had incorrect length values for the crack tips measured from the crack center.
- Bug: Advanced corner crack at hole with a slot and bearing loading reported incorrect RoT limit notifications.
- Bug: COM library notification dialogs prevented silent AFGROW installation.
- Bug: AFGROW set residual stresses to default (1 integration point with 0 residual stress) when any model property was changed for a given model geometry.
- Bug: Error loading residual Ks for the C-direction from a dax file. The K column shifted up by one value.
- Bug: Error loading “2219-T87 lab air T-L” material from the tabular lookup material database.

Added spectrum statistical information to XML output files

```
<Spectrum levels="5" cycles="5101" sub-spectra="5" min-value="-0.5" max-value="1">  
  <PropertyData property="smf">  
    <Data format="double">14</Data>  
  </PropertyData>  
  <PropertyData property="pxx">  
    <Data format="double">0</Data>  
  </PropertyData>  
  <PropertyData property="spl">  
    <Data format="double">0</Data>  
  </PropertyData>  
</Spectrum>
```

Number of
levels

Number of cycles

Number of sub-spectra

- Enhancement: Added an option to reset the AFGROW window layout to a post-installation configuration
- Enhancement: AFGROW migrated to Visual Studio 2022 and InstallShield 2023
- Bug: Model 1090 "Part Through Crack in Pipe" had incorrect parameter limits posted in the help documentation
- Bug: Typos in AFGROW GUI
- Bug: In the Part-Through/Through advanced crack at hole solution, there was an error in the offset correction when crack length is less than hole radius
- Bug: AFGROW did not remove some Tabular-lookup material properties from the Tree View, when a user switches to a different material model
- Bug: API 579 tabular K-solution data for models 5130 and 5131 had erroneous values
- Bug: After Running API 579 Models Through COM, AFGROW hangs in memory
- Bug: Error when calling "CalculateBetas" COM function for API 579 models
- Bug: AFGROW crashed when user opened a file from the Tabular Lookup database, converted units, and saved the converted data
- Bug: Small Error in CorLAS tm Model Failure Fracture Pressure calculations
- Bug: Unreadable notification error reported prior to executing predict when AFGROW checked the validity of input material data
- Bug: AFGROW validated Tabular Lookup data even when the Tabular Lookup material model was not selected

Option to Reset the AFGROW Window Layout to a Post-Installation Configuration

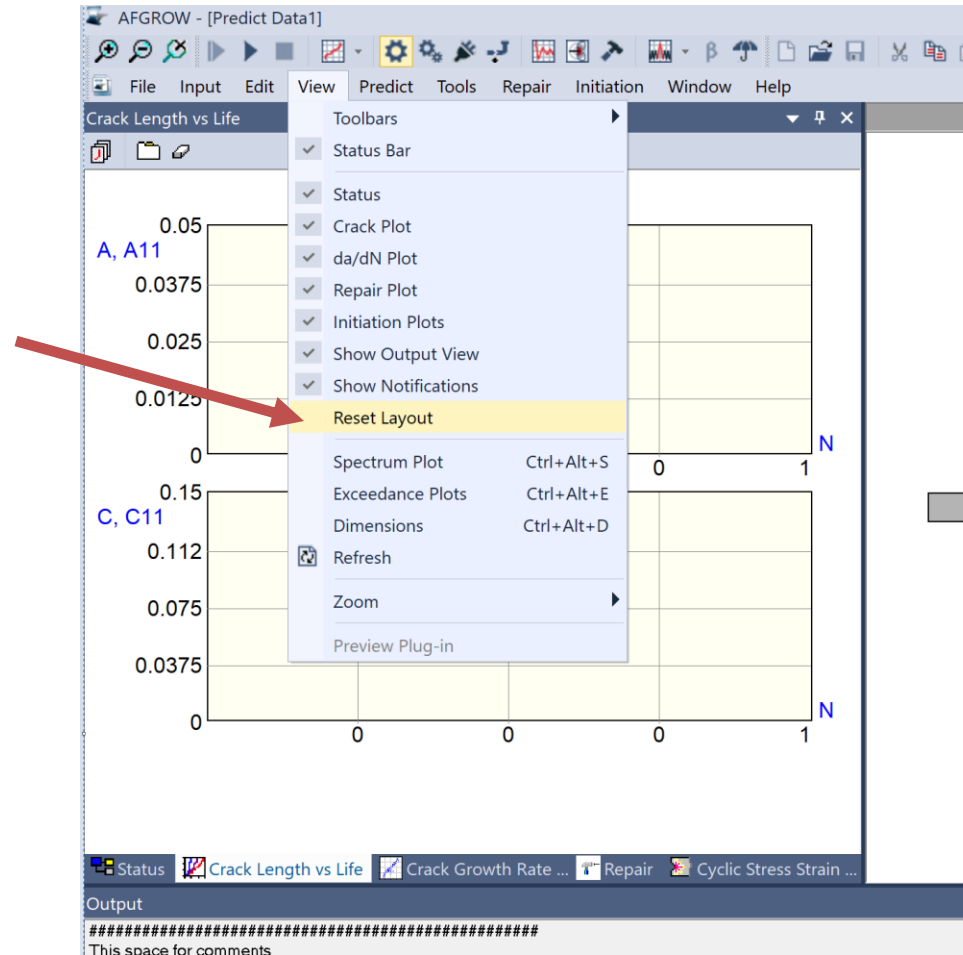

- Enhancement: Improved Advanced Model bearing width correction for through cracks when modeling combinations of part-through/through cracks at a hole
- Enhancement: Corrected the Advanced Model out-of-plane bending solution for a through-the-thickness crack for cases with a secondary crack on the opposite side of the hole. The corrected solution uses the ratio of the Classic single through crack at a hole under bending to the Classic single through crack at a hole under axial loading as the modification factor to the Advanced Model axial load solution for the through-the-thickness crack with a secondary crack on the opposite side of the hole.
- Enhancement: Increase the maximum limit for spectrum cyclic increment in the print output preferences from 10,000 cycles to 500,000.
- Bug: Output file did not include crack growth rate information for Tabular Lookup models
- Bug: For some models, the status of the option to hold a/c constant was not reported in the output file
- Bug: For double cracked advanced models, AFGROW sometimes incorrectly reported net section yield when one of the crack tips was very close to a free edge of the plate
- Bug: Significant spline oscillation errors during Advanced Model K-solution interpolation for combinations of part-through/through cracks at a hole when $a/t < 0.1$
- Bug: Issue applying a polynomial stress distribution for API-579 models 5110, 5111, 5140 and 5141.

AFGROW release 5.5: Completed Items

- Updated the Oblique model solution using Börje's Andersson new data
- Implement the full r/t range for the corner crack/through crack at hole solution option in AFGROW (currently $0.333 \leq R/T \leq 2$, will be 0.1 to 10)
- Added an optional link to open material in AFMAT database when AFGROW is using tabular lookup database
- Updated advanced single corner crack solution with the latest FE data
- Added dA/dN rate summary report
- Added a new COM function to stop prediction on request
- Fixed issue with converting tabular lookup data between English and Metric units
- Add a 2 new crack transition type: THROUGH_TO_SLOT_TRANSITION and PART_THROUGH_TO_SLOT_TRANSITION
- When coping life plot data by clicking on the chart legend, make sure that the copied data in hours, when it is applicable
- Added ability to click on status view item to open the appropriate dialog
- Added new COM events that provide information about every crack direction

AFGROW Release 5.5: Items in Progress

- Add an option for AFGROW to look for spectrum files in the input file folder and predefined spectrum folder on user computer
- Apply K filters for axial and bearing load cases for the MSD Special Case
- Edit the curve names in the "Crack vs Cycles View" by clicking on them
- Add preferences in the Status Tree View
- Add preferences to the output file
- Add units on the AFGROW plots and a status (tree) view
- Add the ability to use mm in model geometry input
- Better "correlation" between crack initiation and growth
- Send events from plugin to the notification list
- Add a crack to a hole using popup menu
- Need to create a COM function, that will allow to open material from the tabular lookup material database
- For 1d User Defined Beta model, calculate K only when C length equal to a length in the Beta Table

Link to Open Material in AFMAT Database Online

Materials
✕

- Material List
- General
- Data Set**

i Input values of Delta_K for da/dN values and up to 10 different R(stress ratio) values. Matrix must have at least two R values and two da/dN values. Input Delta_K for R >= 0, input Kmax for R < 0.0

Name:

Number of da/dn Sets:
Number of R Sets:

		R[1]	R[2]
		0.05	0.6
da/dN[1]	1.00e-09	3.85	2.05
da/dN[2]	2.00e-09	3.851	2.06
da/dN[3]	1.00e-08	3.94	2.175
da/dN[4]	2.00e-08	4.075	2.325
da/dN[5]	4.00e-08	4.4	2.725
da/dN[6]	6.00e-08	4.65	3.1
da/dN[7]	1.00e-07	5.12	3.6
da/dN[8]	2.00e-07	6.3	4.58
da/dN[9]	3.00e-07	7.475	5.48
da/dN[10]	4.00e-07	8.675	6.35
da/dN[11]	6.00e-07	10.475	7.68
da/dN[12]	1.00e-06	12.9	9.485
da/dN[13]	2.00e-06	16.4	12.15
da/dN[14]	4.00e-06	20.75	15.6
da/dN[15]	1.00e-05	30.125	22.5
da/dN[16]	2.00e-05	42	31

[Open in AFMAT database](#)

Ultimate Strength:

Young's Modulus:

Coefficient of Thermal Expansion:

Poisson's Ratio:

Upper limit on da/dN, DADNHI:

Lower limit on da/dN, DADNLO:

Plane Stress Fracture Toughness, KC:

Plane Strain Fracture Toughness, KIC:

Delta K threshold value @R=0:

Yield Strength, YLD :

Lower limit on R shift (Max: 0):

Upper limit on R shift (0, 1):

OK
Cancel
Apply
Add
Delete
Read
Save
Help

dA/dN rate summary report

No growth: 17094
 Rate range bellow 1.0e-10 cycles: 0
 Rate range between 1.0e-10 and 1.0e-09 cycles: 0
 Rate range between 1.0e-09 and 1.0e-08 cycles: 251
 Rate range between 1.0e-08 and 1.0e-07 cycles: 100980
 Rate range between 1.0e-07 and 1.0e-06 cycles: 248203
 Rate range between 1.0e-06 and 1.0e-05 cycles: 69186
 Rate range between 1.0e-05 and 1.0e-04 cycles: 10522
 Rate range between 1.0e-04 and 1.0e-03 cycles: 112
 Rate range between 1.0e-03 and 1.0e-02 cycles: 1

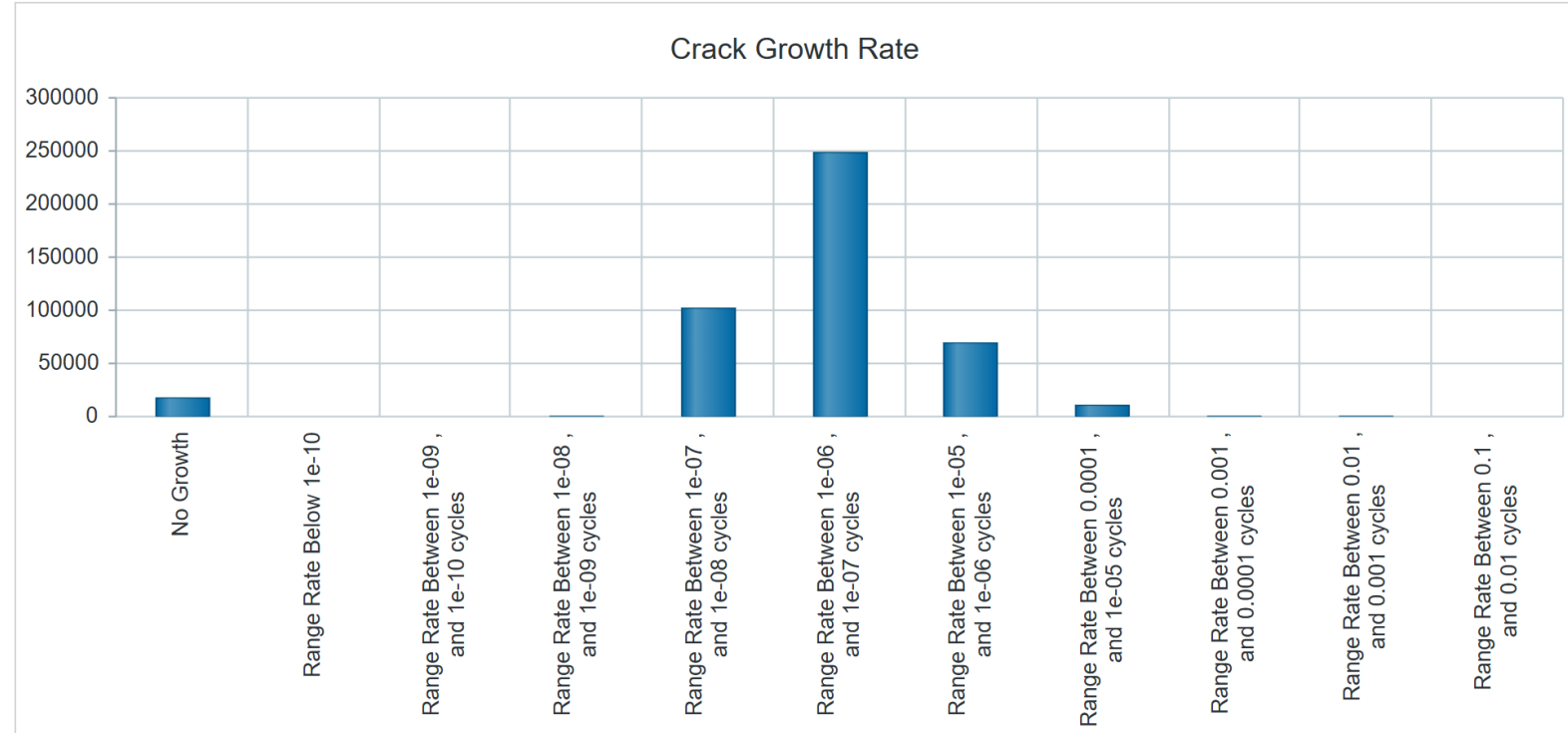

Improved Oblique Model Solution

- Double symmetric crack at hole
- Tabular Solution
- Based on Börje's Andersson SSHF2017 Database: Straight Shank Hole with crack originating at Faying
- New data range:
 - $0.1 \leq A/C \leq 10.0$ old ($0.2 \leq A/C \leq 2.0$)
 - $1.05 \leq A/t \leq 10.0$
 - $0.1 \leq R/t \leq 10.0$ old ($0.5 \leq R/t \leq 2.0$)

New COM Events That Provide Information About Every Crack Direction

- With AFGROW 5.5, there will be new reporting events to provide information about every crack direction for every model
- Previously, there were only up to 4 directions that had information available in events like “*PredictFinished*” and “*PredictInfo*”
- With the new events, information for every direction of every crack will be reported via *iOutputArray* .

```
[id(6)] void PredictFinishedExt(short result, double dblCycles, VARIANT* iOutputArray);  
[id(7)] void PredictInfoExt(AfgrowModels model, double dStress, double dRStress, double dCycles, long dPass, VARIANT* iOutputArray);  
[id(8)] void TransitionInfoExt(long nType, long nReason, double dStress, double dRStress, double dCycles, long dPass, VARIANT* iOutputArray);  
[id(9)] void FractureInfoExt(long nReason, double dStress, double dRStress, double dCycles, long dPass, VARIANT* iOutputArray);
```

Spectrum Manager 1.3 (AFGROW Release 5.5)

- Filter exceedance data by damage tags
- Cycle counting
- Ability to concatenate spectra
- Auto sequencing

Damage Tag Filter on Exceedance Plot

- Filter the Exceedance Plot by damage tags in the Spectrum
- Can Filter by “Entire Spectrum (Default View), All Damage Tags (All levels with damage tags), No Damage Tag (only levels without any damage tag), and each individual damage tag
- Can also select multiple damage tags to view at once
- Only visible if you have Damage tags enabled in the Spectrum Options

Damage Tag Filter on Exceedance Plot

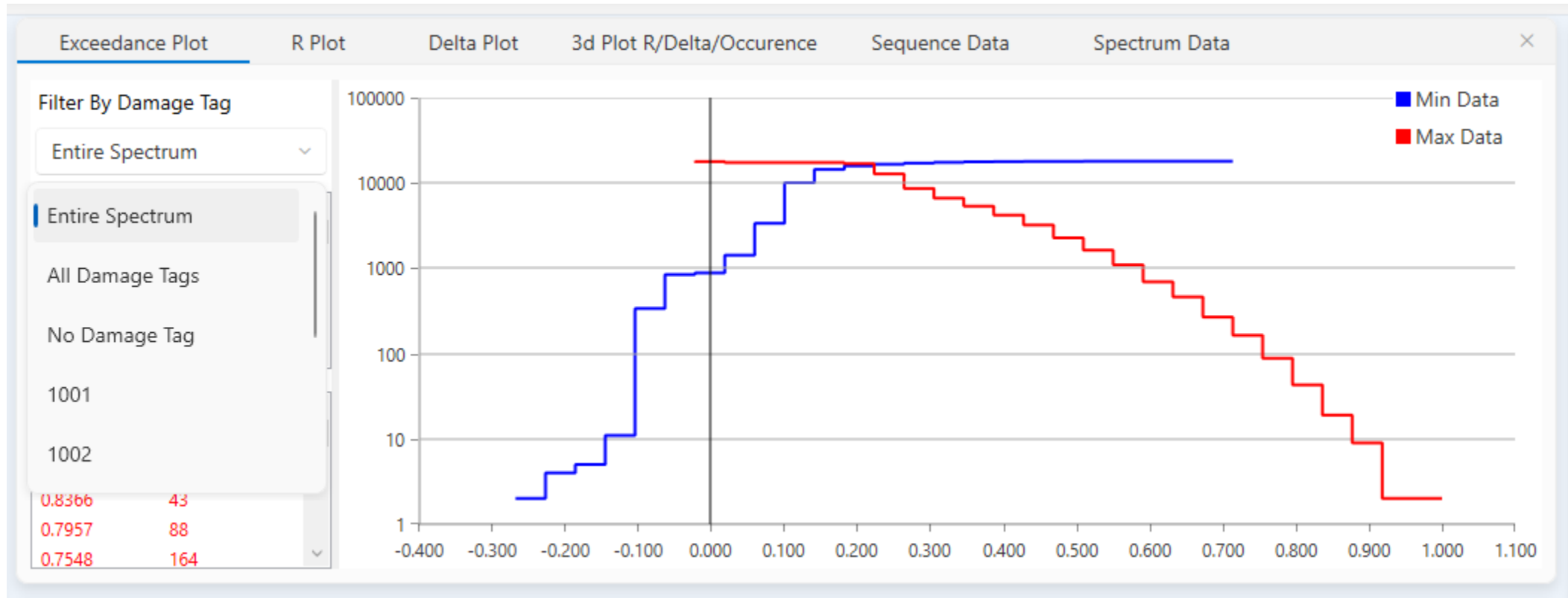

Damage Tag Filter on Exceedance Plot

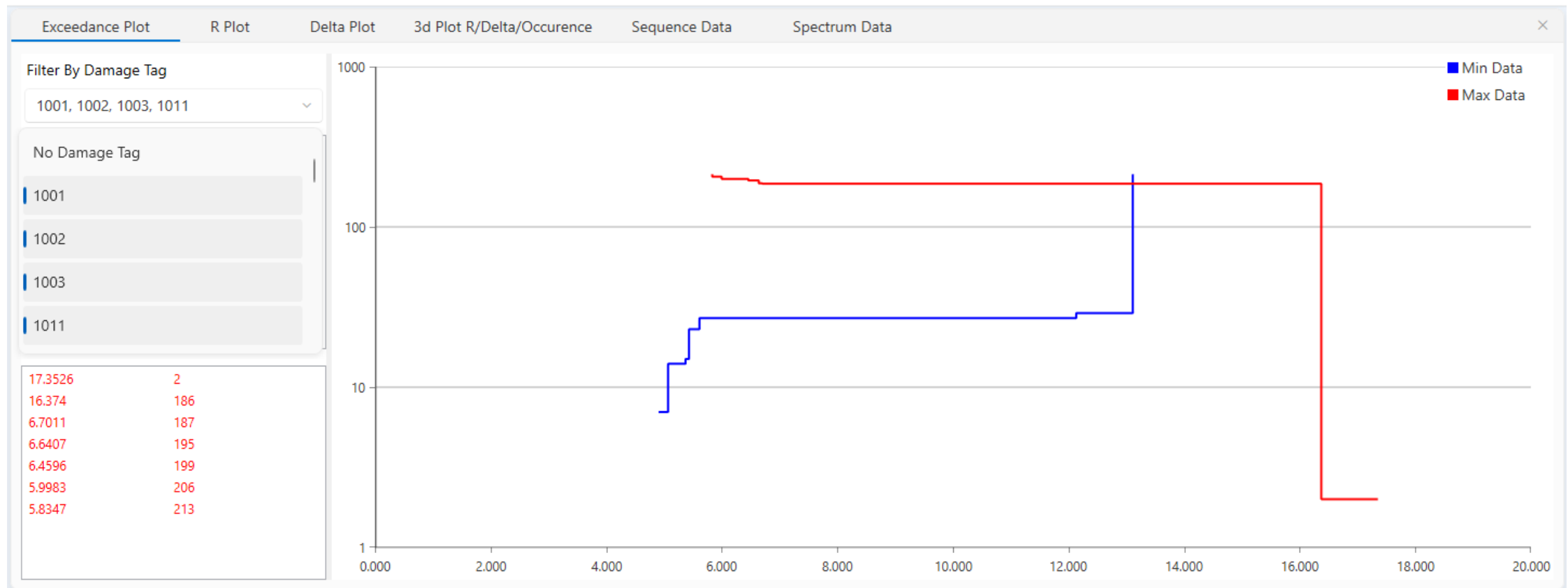

Cycle Count

- Create a cycle counted sub-spectrum from time sampled or peak-valley uncounted input data
- Ability to apply damage tags to uncounted data
- Three different cycle counting options:
 - Modified Rain-Flow counting routine, was originally available in Cycle Counting application distributed with AFGROW
 - Simplified Rain-Flow counting routine IAW: ASTM E1049-85
 - Range-Pair counting routine IAW: ASTM E1049-85
- Option to select if you wish the resulting sub spectrum to be normalized
- New counted Sub Spectrum will be added to the end of the Sub Spectra Library
- Symbol will appear next to the name in library to indicate that the Sub Spectrum is from uncounted data
- The pick-valley uncounted input data are saved with the sub spectrum and could be exported on demand

Cycle Count

Spectrum Manager - C:\Users\Jimmy\Documents\afgrow\Spectra\CycleCounting\flight1reversals.spx

[Edit](#)
[Preview Spectrum](#)
[View](#)
[Preview Reversals](#)

Project Window

- Flight1Reversals
 - Sub-spectra Library
 - Flight 1
 - Reversals
 - Sequence

Exceedance Plot | R Plot | Delta Plot | 3d Plot R/Delta/Occurrence | Sequence Data | Spectrum Data | Reversal Data

#	cycle	Max	Min	Cycles
1	14.522	10.561	2	
3	14.522	11.881	1	
4	13.202	11.881	1	
5	15.842	11.881	1	
6	15.842	13.202	1	
7	15.842	9.241	1	
8	13.202	10.561	1	
9	11.881	10.561	1	
10	14.522	11.881	1	
11	14.522	13.202	3	
14	15.842	10.561	1	
15	13.202	11.881	4	
19	14.522	11.881	1	
20	15.842	11.881	1	
21	14.522	13.202	1	

Properties Window

Sub-spectrum

Name: Flight 1

Description:

Statistics

Number Of Levels	4394
Number Of Cycles	6326
Max	20.784
Min	0
Max Delta	20.784
Min Delta	0.006000000000000000
Occurrences in Sequ	1

Reversals Chart

Flight 1

9/14 | Flight1Reversals

Concatenate Spectra

- Combine two spectra together
- Prompt will appear to use the current spectrum's Label to auto-generate names
- Damage Tag, Environment Tag, and Time Dependence data will be lost when concatenating the spectra

Concatenate Spectra

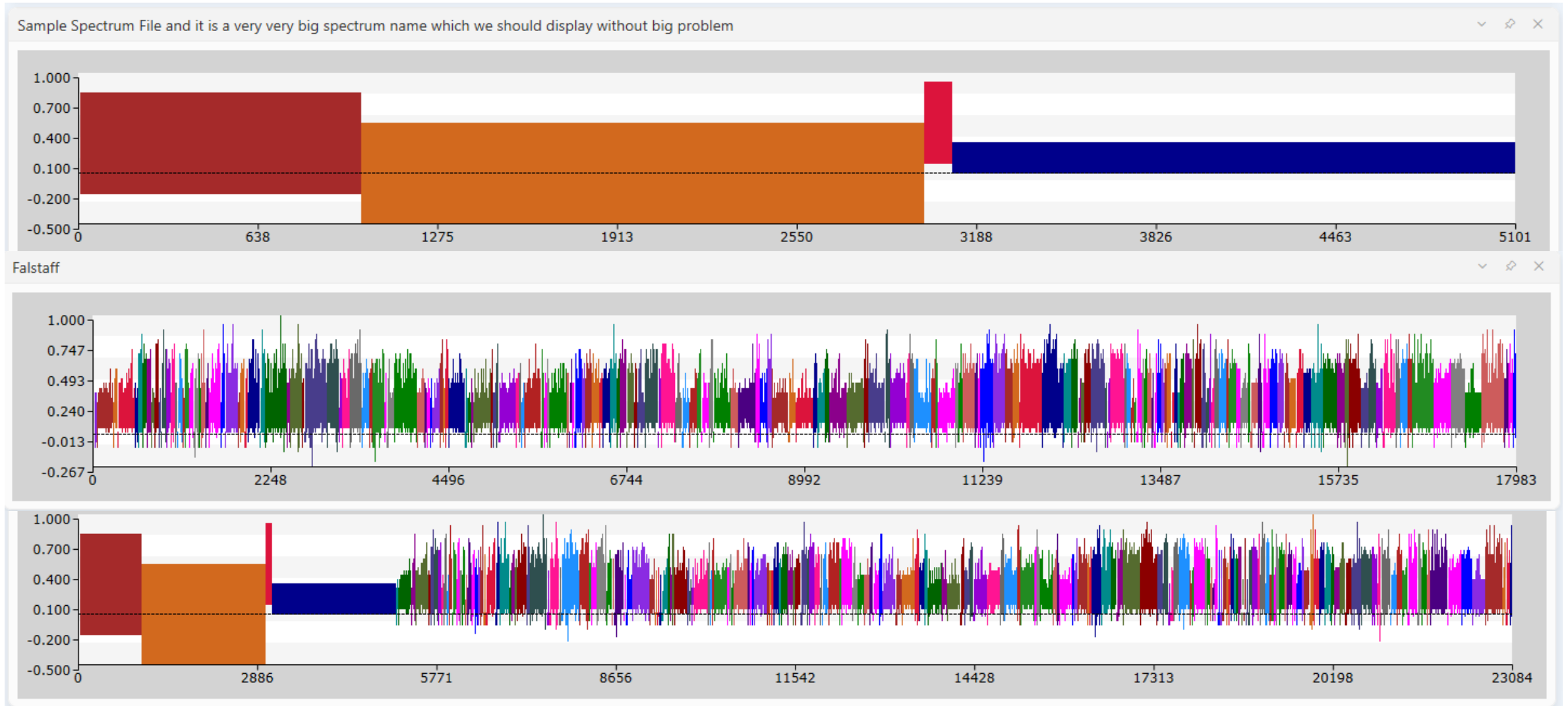

Auto Sequence

- Automatically add the Sub Spectra in the Sub Spectra Library to the Sequence
- Can modify the number of times a Sub Spectra appears in the sequence by changing the Occurrences value next to the Sub Spectrum name.
- These additional occurrences will be sequential.

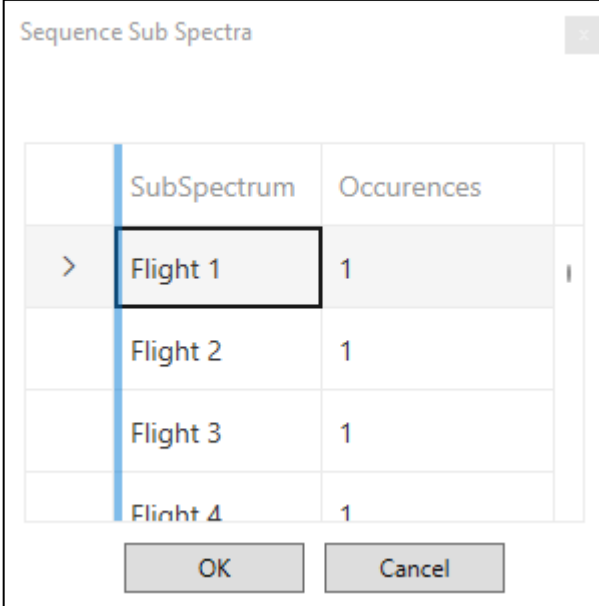

Sequence Sub Spectra

	SubSpectrum	Occurrences
>	Flight 1	1
	Flight 2	1
	Flight 3	1
	Flight 4	1

OK Cancel

AFGROW Post-Processing Web Application

What is the AFGROW Post-processing Application?

- The AFGROW Post-processing Application is a web app that can be accessed from your browser which organizes data from AFGROW .xml output files. After uploading a file, the application generates several tables and plots that can assist the user in evaluating AFGROW crack growth prediction results.
- When you securely upload an AFGROW xml output file to our server, the web application processes the results to create helpful graphs and tables in your browser. **We do not save any user submitted data.**

How To Access and Use the Post-processing Application

The AFGROW Post-processing Web Application is live now. You can access it at <https://www.afgrow.net/post-processing>. To upload your file, click *File Upload* or Drag and Drop your file in the upload designated area. Then, click *Choose File* and select the file you wish to upload and evaluate with the app. After selecting a file, its name will be visible next to the *Choose File* button. Finally, Click *Generate Report*. A page should now be loaded with your post-processing results.

Post-processing: Application Features

The Post-processing Application has several sections, each of which present information related to the different components of the analysis. All plots and data tables display the units of the reported data. All the reported data can be exported and a text of as a picture, when it is appropriate. The complete report page can be saved as pdf file.

You may see even more sections than those listed below. These sections can be used to give additional perspective about the prediction results. As we improve this tool, more sections will become available. It is still work in progress.

- Model Description
- Spectrum Information
- Crack Growth Output
- Crack Length vs Life Sections
- Beta vs Life Sections
- K v Crack Length Section
- Beta Vs Crack Length Section
- AoC vs Life Section
- AoT vs Life Section
- Crack Growth Rate Summary Section
- Damage Tag Summary Section

Post-processing: Model Description

The Model Description section gives the highest-level analysis of the AFGROW prediction. It includes the model, final cycles, and final crack lengths for a quick overview of the results of the prediction.

Model Description

Model: Internal Through Crack - Standard Solution (2010)

Name: Example Problem

Comments: This space for comments

Final Cycles: 4924120

Final Crack Length: 1.31193

Post-processing: Spectrum Information

The Spectrum Section gives a brief summary of the spectrum used for the AFGROW prediction. This includes the number of levels and cycles in the spectrum, as well as the min and max spectrum values, and the Stress Multiplication Factor.

Spectrum

Spectrum File: C:\Users\aliv\Documents\AFGROW\Spectra\dfstaf.sp3

Spectrum Multiplacation Factor: 14

Residual Strength Requirement: 0

Preload: 0

Levels: 15674

Cycles: 17983

Subspectra: 200

Max Value: 1

Min Value: -0.2667

Post-processing: Crack Growth Output

Crack Growth Output ^

Export to Excel

Crack Id ▼	AoT	AoC	Direction Id ▼	Length (in)	Beta Tension	Beta Cor
0	0	0	C	0.15	1.00334	1.00334
0	0	0	C	0.16	1.00369	1.00369
0	0	0	C	0.17	1.00407	1.00407
0	0	0	C	0.18	1.00449	1.00449
0	0	0	C	0.19	1.00495	1.00495
0	0	0	C	0.200001	1.00546	1.00546
0	0	0	C	0.210001	1.00603	1.00603
0	0	0	C	0.220001	1.00665	1.00665
0	0	0	C	0.230004	1.00734	1.00734

◀
◀
1
2
3
4
5
...
▶
▶
10
▼ items per page
 1 - 10 of 118 items ↻

Post-processing: Crack Length vs Life

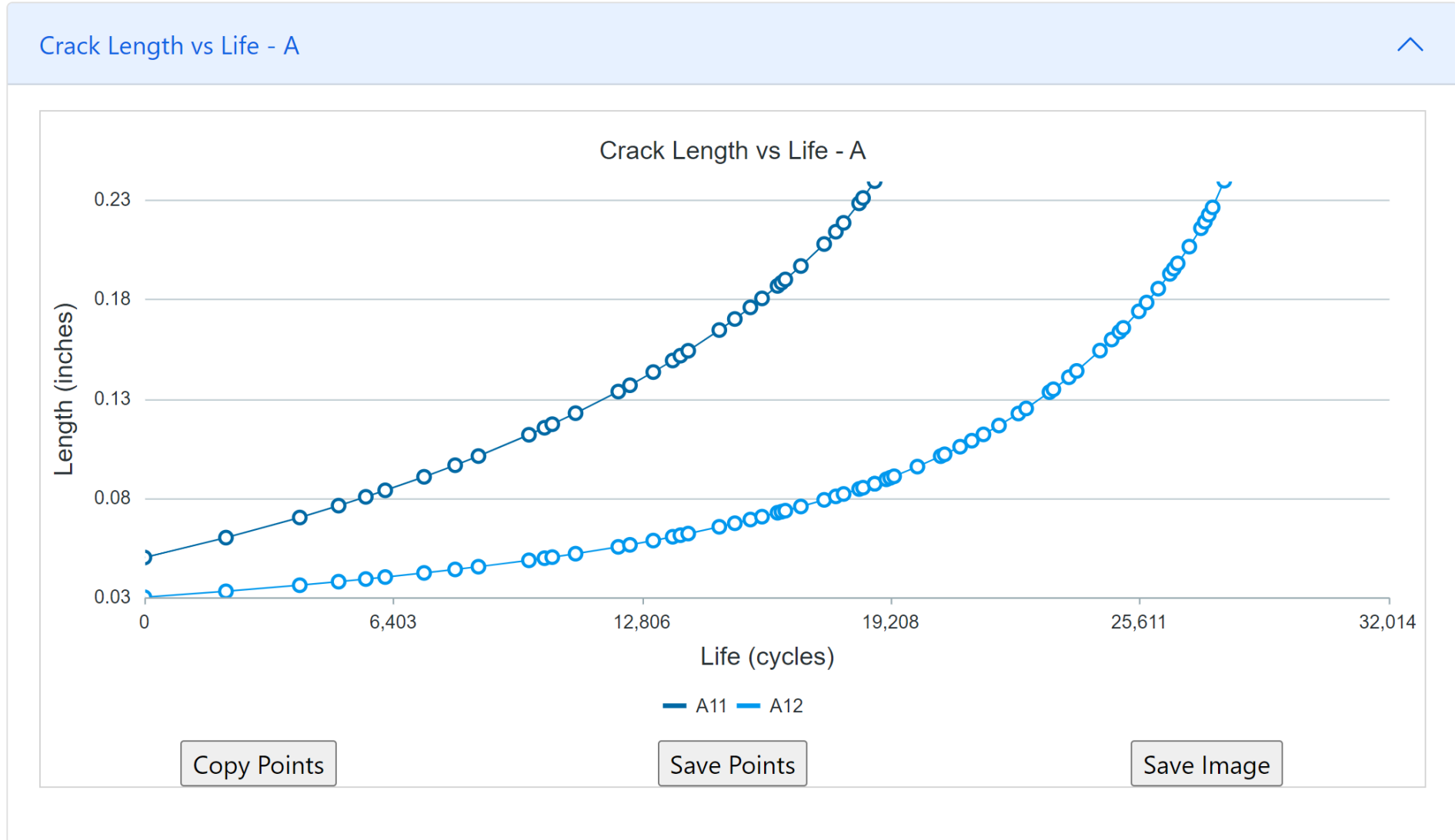

Post-processing: Beta vs Life



Post-Processing: AoC vs Life

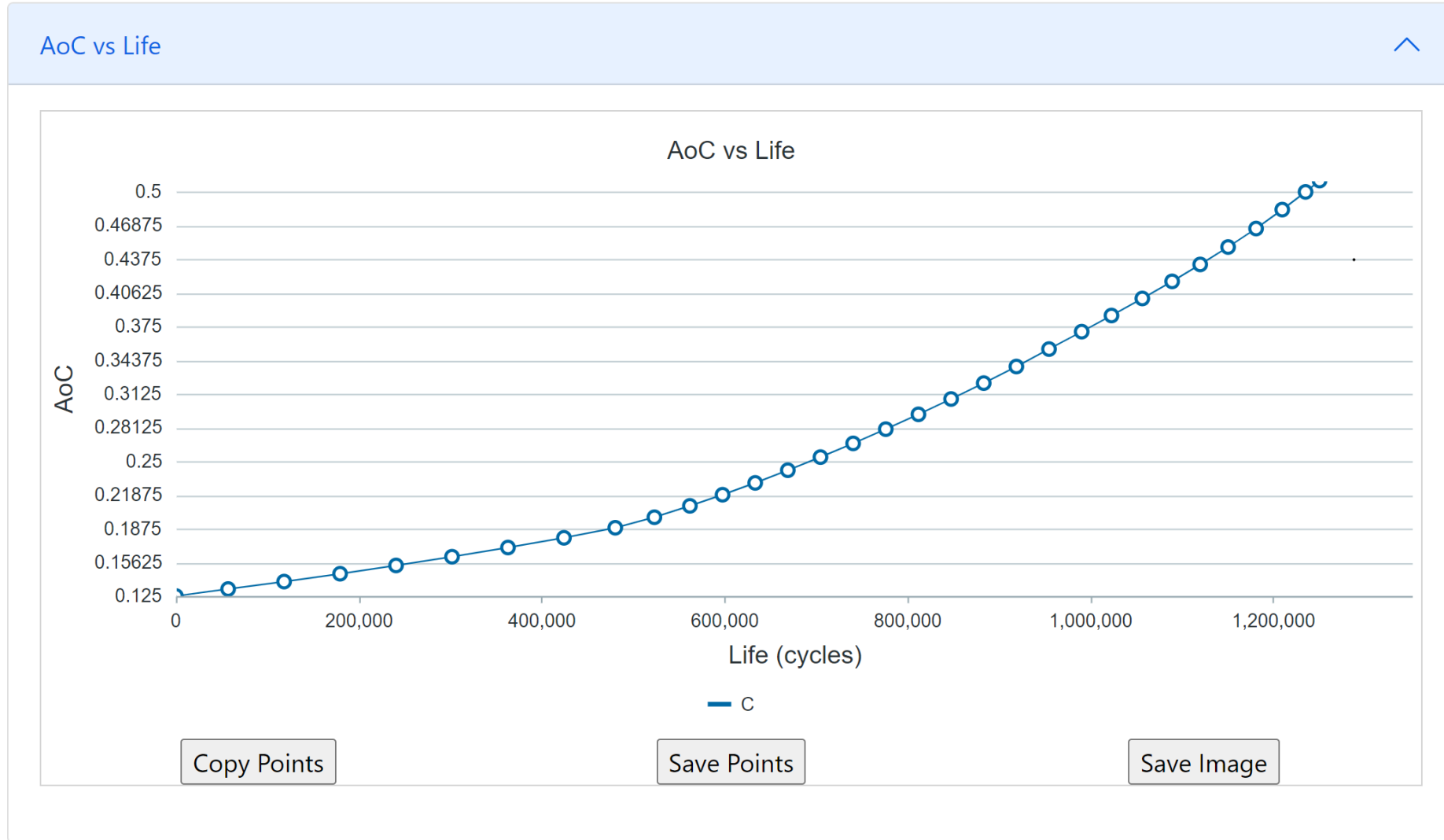

Post-processing: Crack Growth Rate Summary

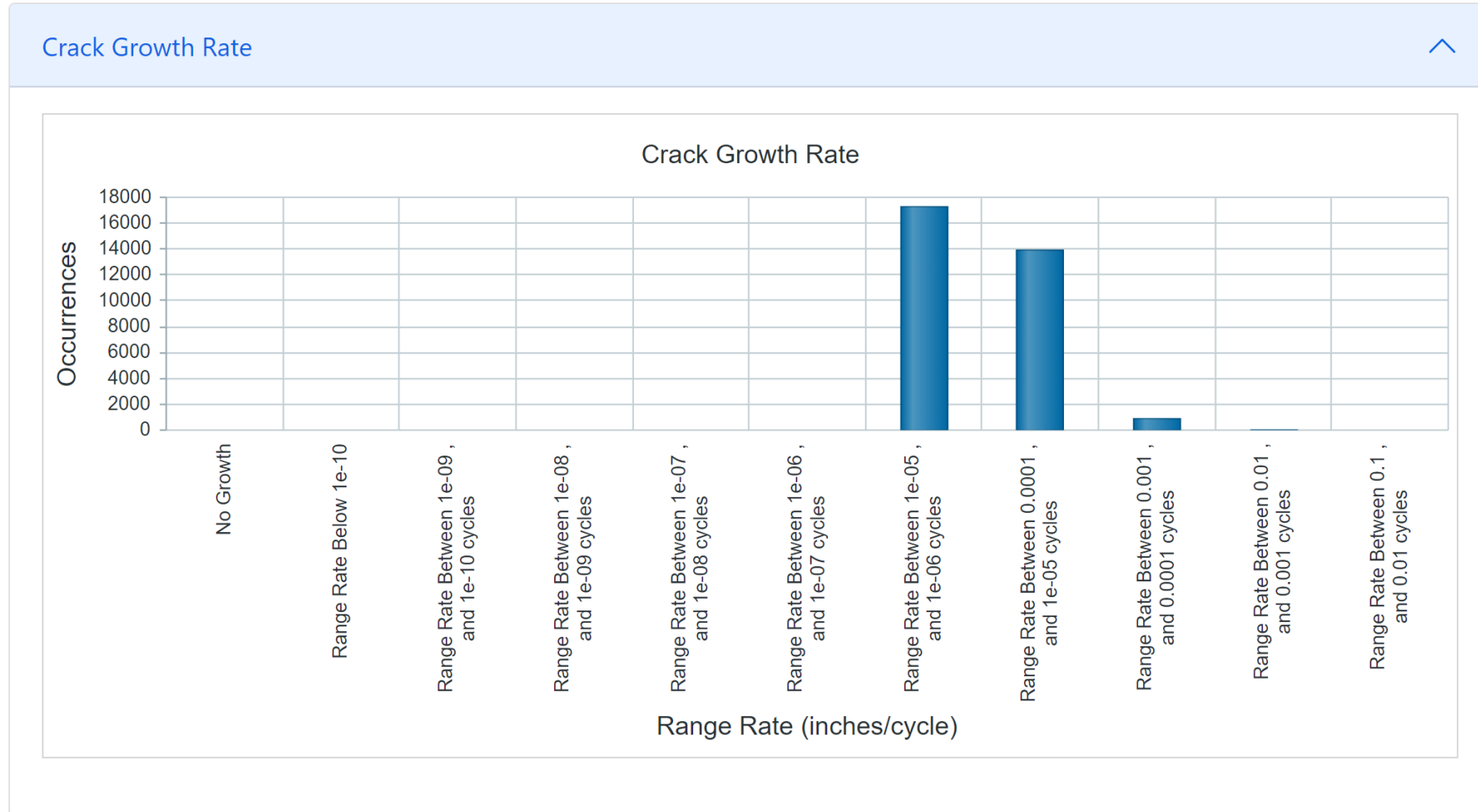

Post-processing: Damage Tag Summary

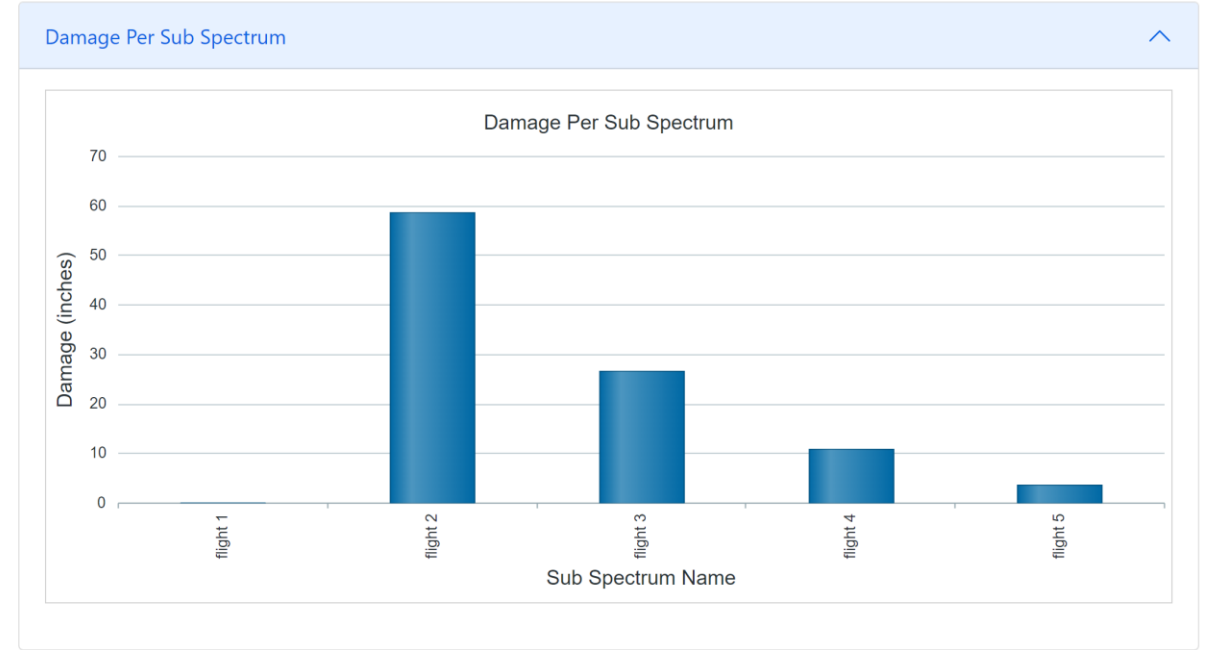
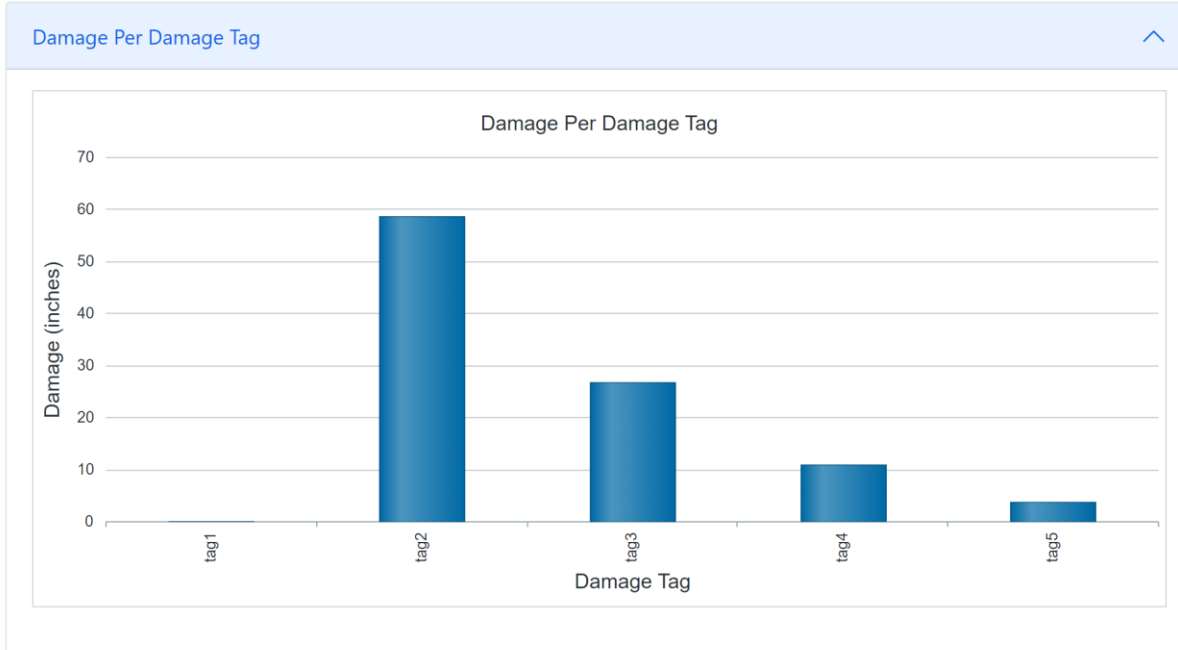

Acknowledgements

- A-10 and T-38 Structural Integrity and Analysis Group
- ASIMIS
- AFGROW Customers and Consortium Members

Questions